

6.003: Signal Processing

Impulse Response and Convolution

- Unit Sample Signal and Unit Sample Response
- Discrete-Time Convolution
- Impulse Function and Impulse Response
- Continuous-Time Convolution

Homework 6 is posted.

- Lab 6 check-in due Friday at 4pm.

October 12, 2021

Last Time: The System Abstraction

Describe a **system** (physical, mathematical, or computational) by the way it transforms an **input signal** into an **output signal**.

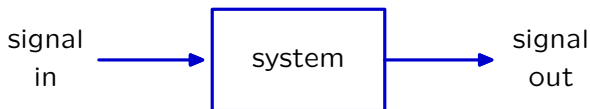

This abstraction is particularly powerful for **linear and time-invariant** systems, which are both **prevalent** and **mathematically tractable**.

Three important representations for LTI systems:

- **Difference Equation:** algebraic **constraint** on samples ✓
- **Convolution:** represent a system by its **unit-sample response**
- **Filter:** represent a system by its **frequency response**

Linear Difference Equations with Constant Coefficients

If a discrete-time system can be described by a linear difference equation with constant coefficients, then the system is linear and time-invariant.

General form:

$$\sum_l c_l y[n-l] = \sum_m d_m x[n-m]$$

Such systems are easily shown to be linear and time-invariant.

Additivity: output of sum is sum of outputs

$$\sum_l c_l (y_1[n-l] + y_2[n-l]) = \sum_m d_m (x_1[n-m] + x_2[n-m]) \quad \checkmark$$

Homogeneity: scaling an input scales its output

$$\sum_l c_l (\alpha y[n-l]) = \sum_m d_m (\alpha x[n-m]) \quad \checkmark$$

Time invariance: delaying an input delays its output

$$\sum_l c_l y[(n-n_0)-l] = \sum_m d_m x[(n-n_0)-m] \quad \checkmark$$

Linear Differential Equations with Constant Coefficients

If a continuous-time system can be described by a linear differential equation with constant coefficients, then the system is linear and time-invariant.

General form:

$$\sum_l c_l \frac{d^l y(t)}{dt^l} = \sum_m d_m \frac{d^m x(t)}{dt^m}$$

Such systems are easily shown to be linear and time-invariant.

Additivity: output of sum is sum of outputs

$$\sum_l c_l \left(\frac{d^l y_1(t)}{dt^l} + \frac{d^l y_2(t)}{dt^l} \right) = \sum_m d_m \left(\frac{d^m x_1(t)}{dt^m} + \frac{d^m x_2(t)}{dt^m} \right) \quad \checkmark$$

Homogeneity: scaling an input scales its output

$$\sum_l c_l \left(\alpha \frac{d^l y(t)}{dt^l} \right) = \sum_m d_m \left(\alpha \frac{d^m x(t)}{dt^m} \right) \quad \checkmark$$

Time invariance: delaying an input delays its output

$$\sum_l c_l \frac{d^l y(t - \tau)}{dt^l} = \sum_m d_m \frac{d^m x(t - \tau)}{dt^m} \quad \checkmark$$

Today: Representing a System by its Unit-Sample Response

Describe a **system** (physical, mathematical, or computational) by the way it transforms an **input signal** into an **output signal**.

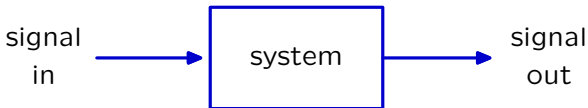

This abstraction is particularly powerful for **linear and time-invariant** systems, which are both **prevalent** and **mathematically tractable**.

Three important representations for LTI systems:

- **Difference Equation:** algebraic **constraint** on samples ✓
- **Convolution:** represent a system by its **unit-sample response**
- **Filter:** represent a system by its **frequency response**

Superposition

Break the input signal into additive parts and sum responses to the parts.

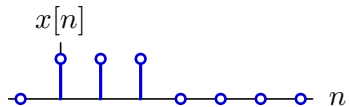

Superposition

Break the input signal into additive parts.

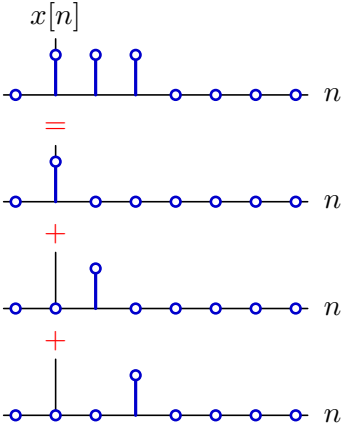

Superposition

Find the response to each part.



=

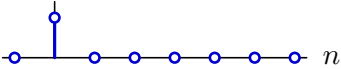

+

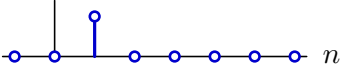

+

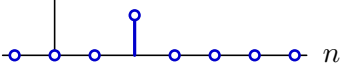

→

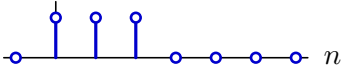

Superposition

Find the response to each part.

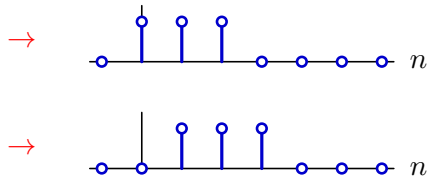
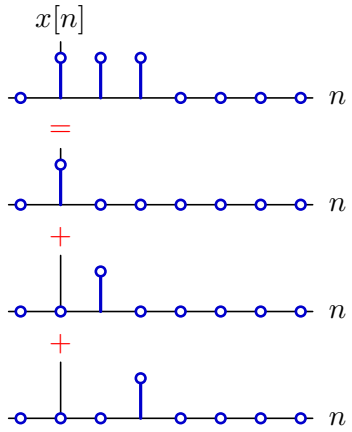

Superposition

Find the response to each part.

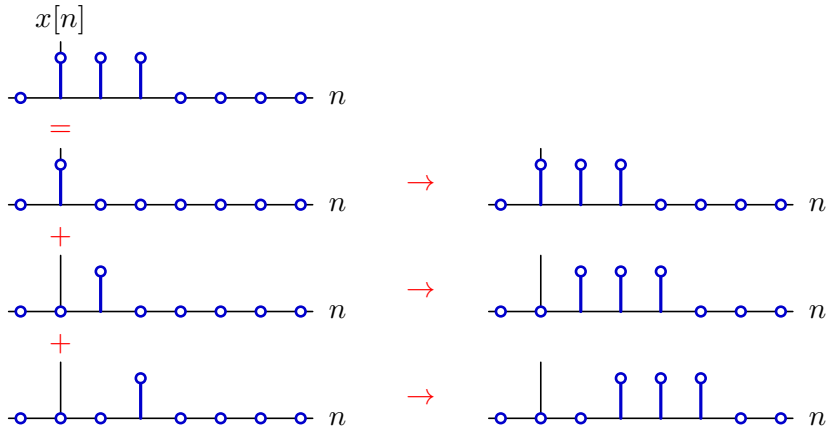

Superposition

Add the responses to the parts.

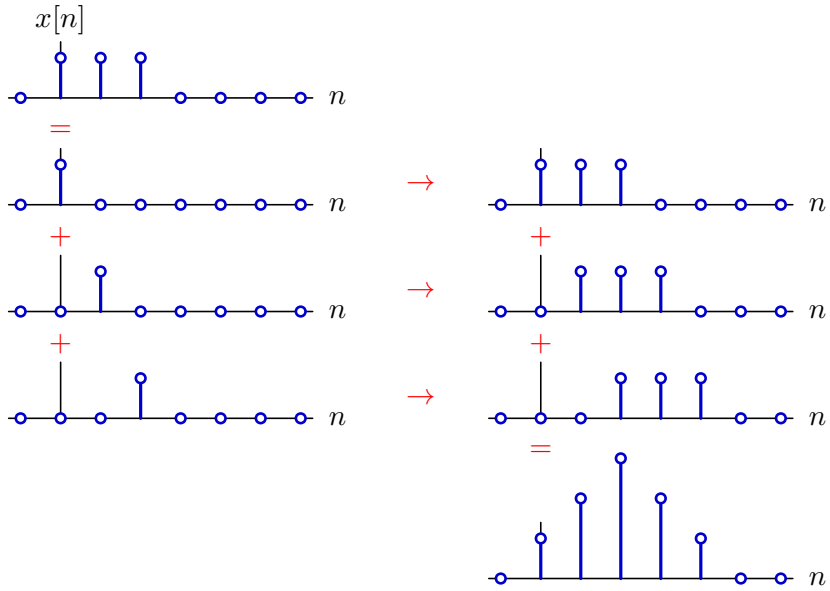

Superposition

Superposition works because the system is **linear**.

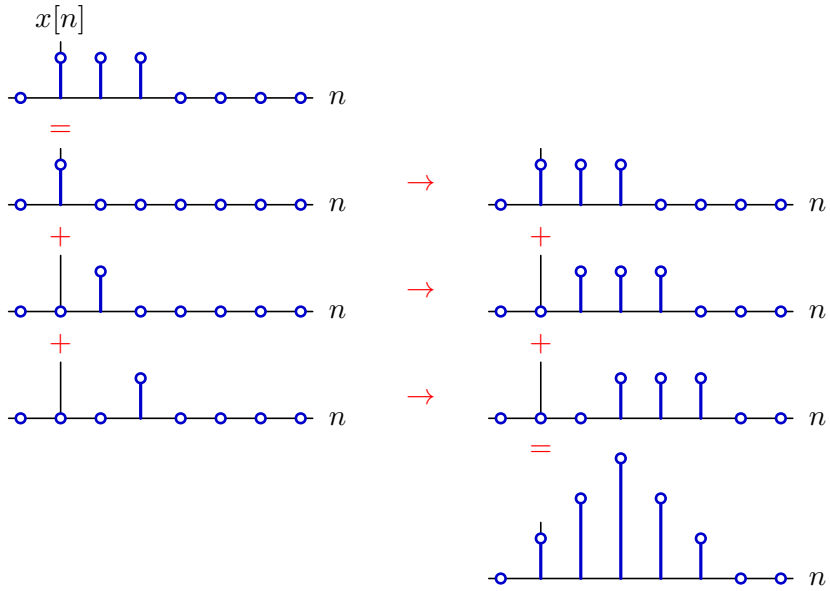

Linearity

A system is linear if its response to a weighted sum of inputs is equal to the weighted sum of its responses to each of the inputs.

Given

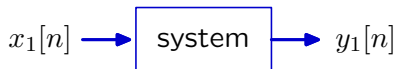

and

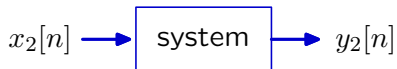

the system is linear if

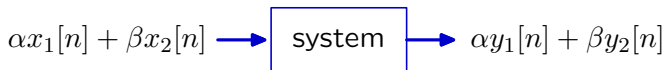

is true for all α and β and all times n .

Superposition

Responses to parts are easy to compute if system is **time-invariant**.

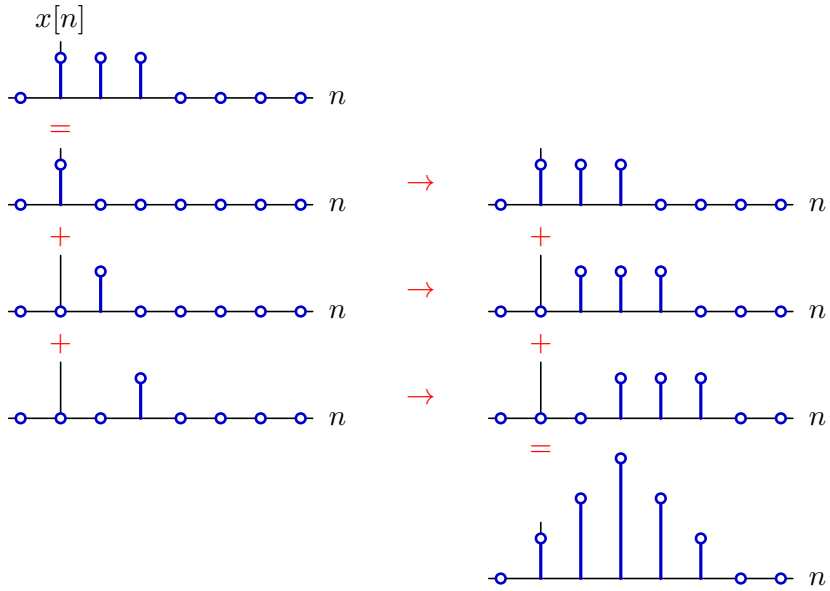

Time-Invariance

A system is time-invariant if delaying the input to the system simply delays the output by the same amount of time.

Given

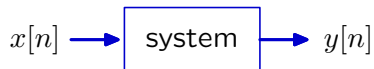

the system is time invariant if

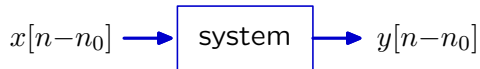

is true for all n and all n_0 .

Superposition

Superposition is easy if the system is **linear** and **time-invariant**.

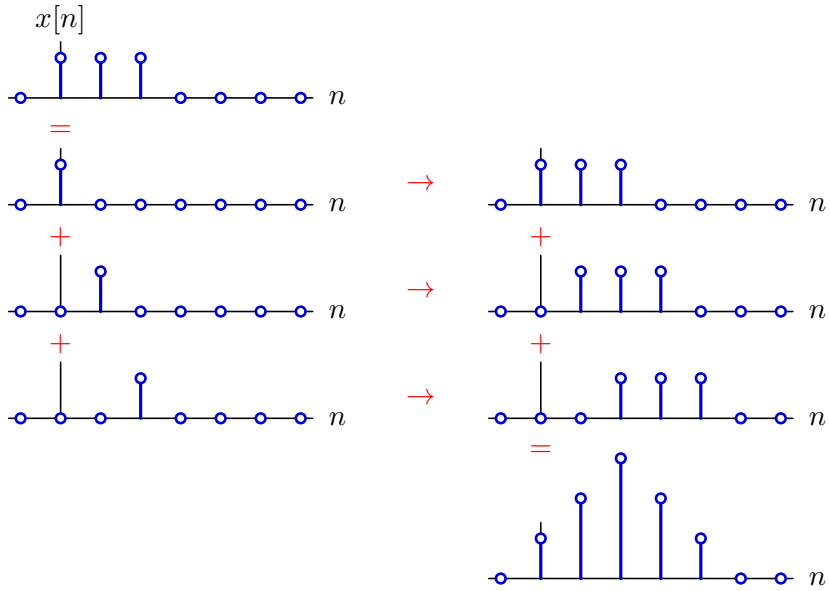

Illustrates importance of **unit sample signal** and **unit sample response**.

Unit-Sample Response

If a system is linear and time-invariant (LTI), its input-output relation is **completely specified** by the system's unit-sample response $h[n]$.

1. One can always find the unit-sample response of a system.

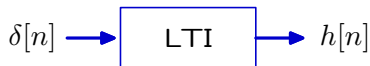

2. Time invariance implies that shifting the input simply shifts the output.

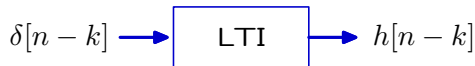

3. Homogeneity implies that scaling the input simply scales the output.

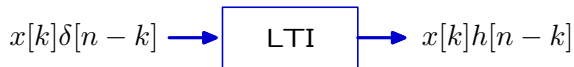

4. Additivity implies that the response to a sum is the sum of responses.

$$x[n] = \sum_{k=-\infty}^{\infty} x[k]\delta[n - k] \longrightarrow \text{LTI} \longrightarrow y[n] = \sum_{k=-\infty}^{\infty} x[k]h[n - k] \equiv (x * h)[n]$$

Convolution

The response of an LTI system to an arbitrary input $x[n]$ can be found by **convolving** that input with the unit-sample response $h[n]$ of the system.

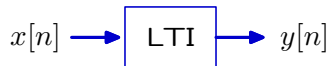

$$y[n] = \sum_{k=-\infty}^{\infty} x[k]h[n-k] \equiv (x * h)[n]$$

Notation

Convolution is represented with an asterisk.

$$\sum_{k=-\infty}^{\infty} x[k]h[n-k] \equiv (x * h)[n]$$

It is customary (but confusing) to abbreviate this notation:

$$(x * h)[n] = x[n] * h[n]$$

$x[n] * h[n]$ looks like an operation of samples; but it is not!

$$x[1] * h[1] \neq (x * h)[1]$$

Convolution operates on signals not samples.

Unambiguous notation:

$$\sum_{k=-\infty}^{\infty} x[k]h[n-k] \equiv (x * h)[n]$$

The symbols x and h represent DT signals.

Convolving x with h generates a new DT signal $x * h$.

Structure of Convolution

Focus on computing the n^{th} output sample.

$$y[n] = \sum_{k=-\infty}^{\infty} x[k]h[n-k]$$

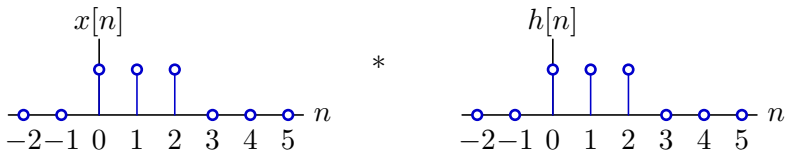

Structure of Convolution

Focus on computing the n^{th} output sample: start with $n = 0$.

$$y[0] = \sum_{k=-\infty}^{\infty} x[k]h[0 - k]$$

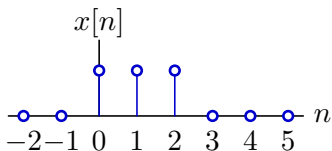

*

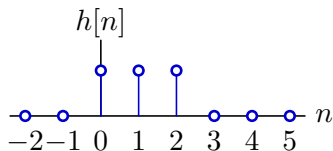

Structure of Convolution

The sum is over $x[k]$ (not $x[n]$).

$$y[0] = \sum_{k=-\infty}^{\infty} x[k]h[0-k]$$

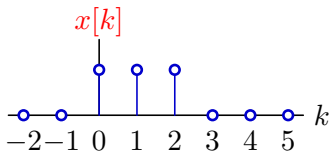

*

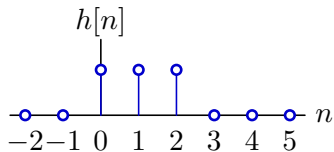

Structure of Convolution

The sum is over $x[k]$ and $h[-k]$ ($h[k]$ is **flipped**).

$$y[0] = \sum_{k=-\infty}^{\infty} x[k]h[0 - k]$$

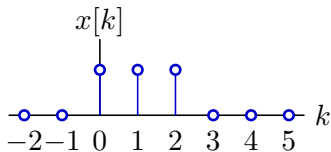

flip

*

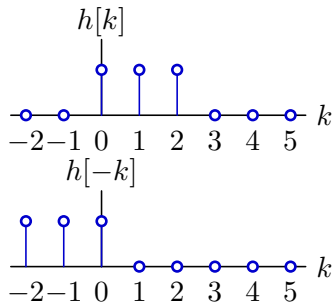

Structure of Convolution

Focus on computing the n^{th} output sample.

$$y[0] = \sum_{k=-\infty}^{\infty} x[k]h[0 - k]$$

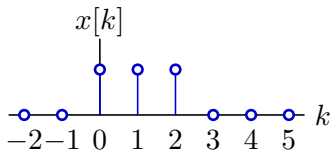

shift

*

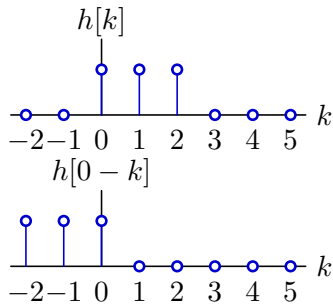

Structure of Convolution

Focus on computing the n^{th} output sample.

$$y[0] = \sum_{k=-\infty}^{\infty} x[k]h[0 - k]$$

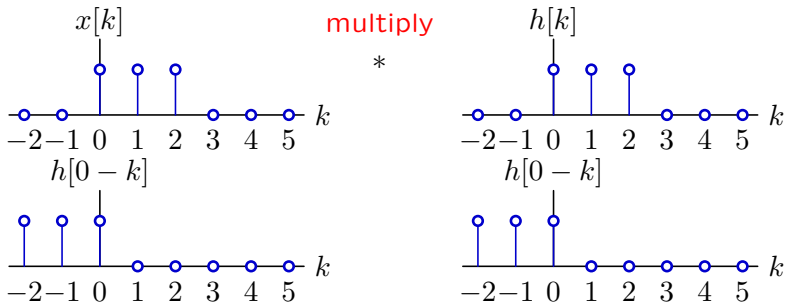

Structure of Convolution

Focus on computing the n^{th} output sample.

$$y[0] = \sum_{k=-\infty}^{\infty} x[k]h[0-k]$$

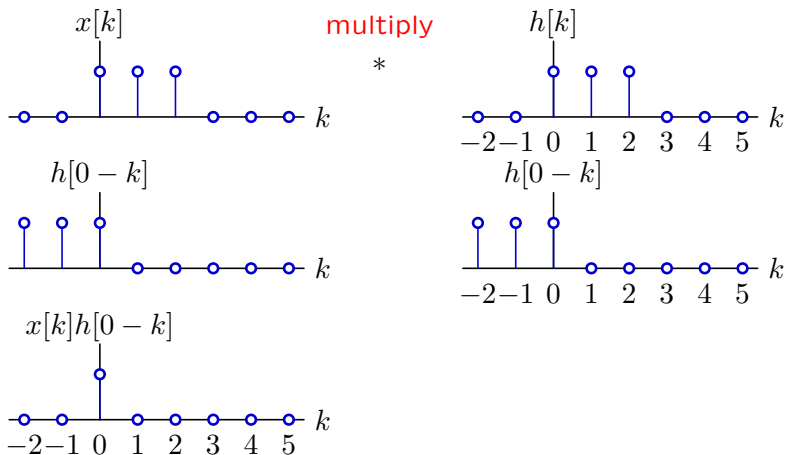

Structure of Convolution

Focus on computing the n^{th} output sample.

$$y[0] = \sum_{k=-\infty}^{\infty} x[k]h[0-k]$$

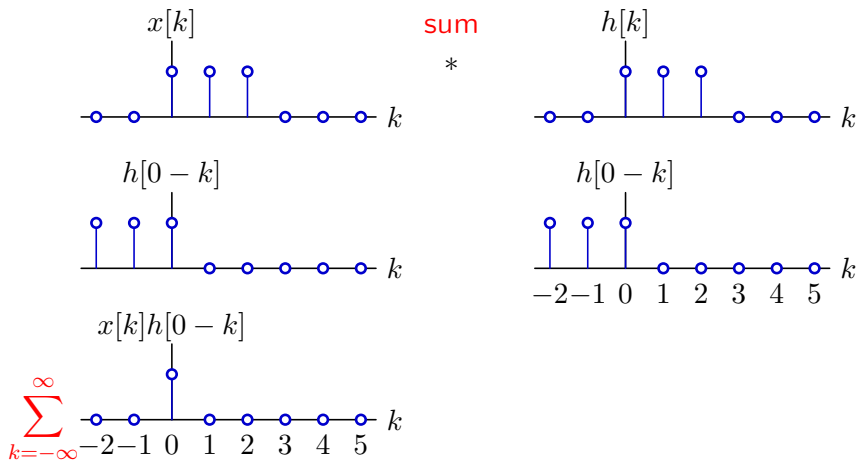

Structure of Convolution

Focus on computing the n^{th} output sample.

$$y[0] = \sum_{k=-\infty}^{\infty} x[k]h[0-k]$$

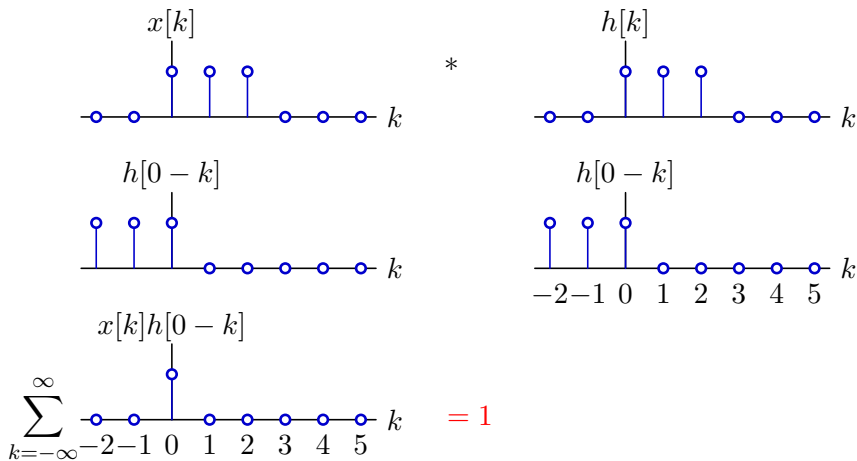

Structure of Convolution

Focus on computing the n^{th} output sample.

$$y[1] = \sum_{k=-\infty}^{\infty} x[k]h[1-k]$$

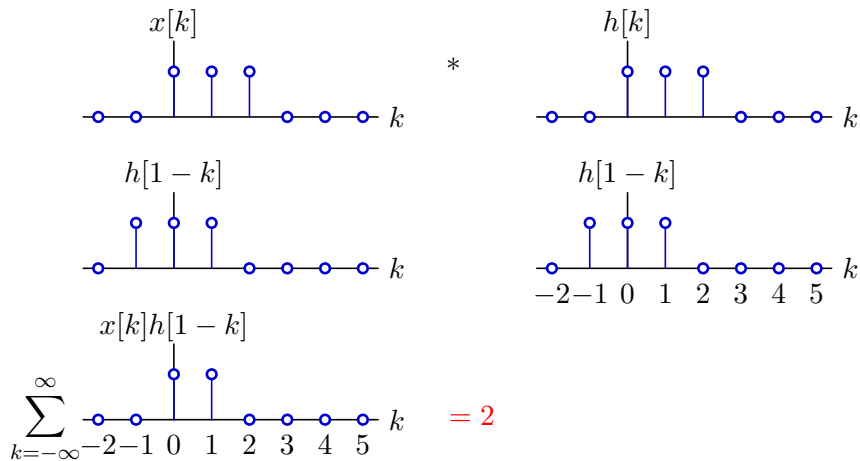

Structure of Convolution

Focus on computing the n^{th} output sample.

$$y[2] = \sum_{k=-\infty}^{\infty} x[k]h[2-k]$$

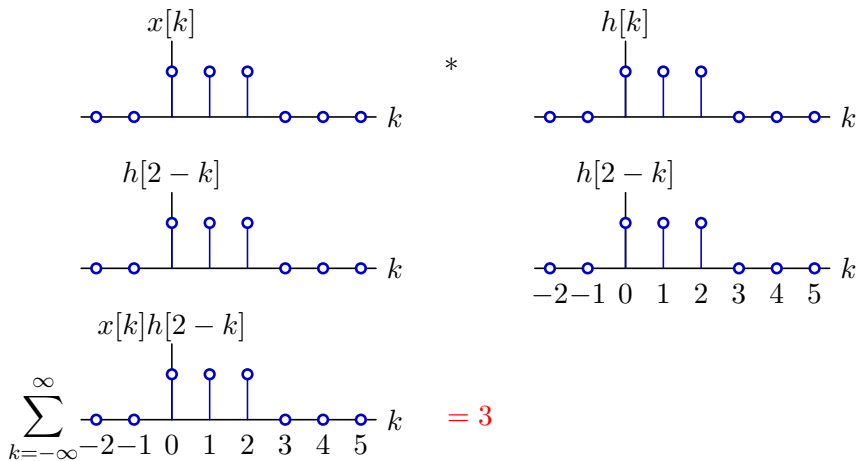

Structure of Convolution

Focus on computing the n^{th} output sample.

$$y[3] = \sum_{k=-\infty}^{\infty} x[k]h[3-k]$$

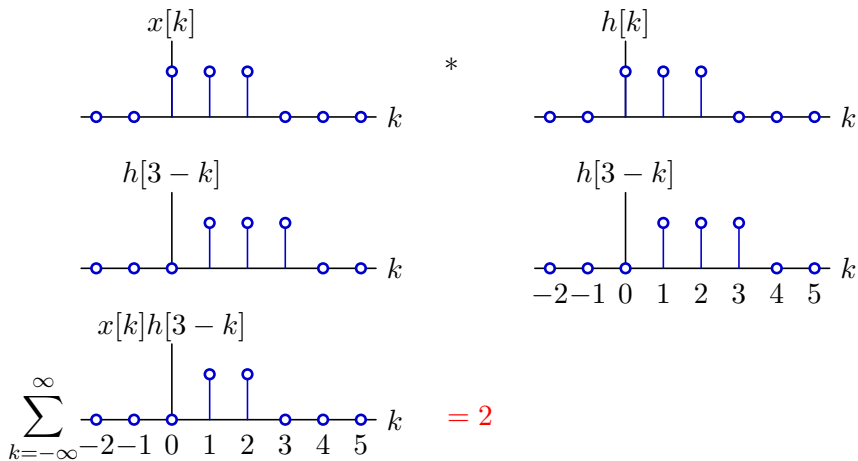

Structure of Convolution

Focus on computing the n^{th} output sample.

$$y[4] = \sum_{k=-\infty}^{\infty} x[k]h[4-k]$$

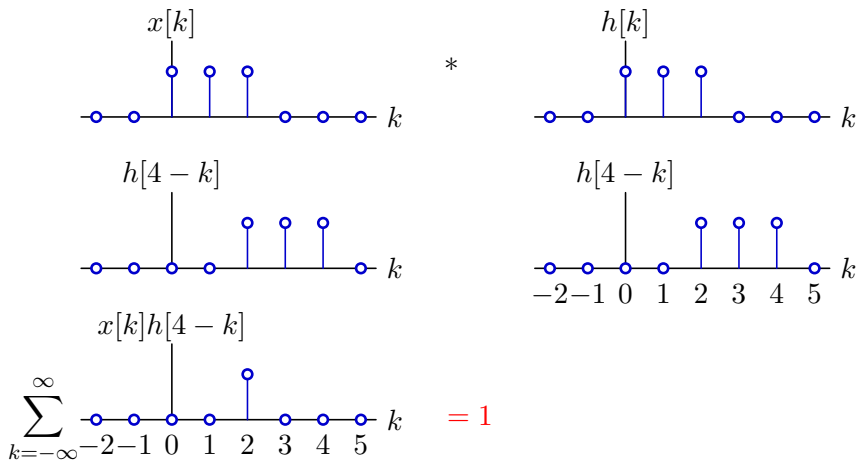

Structure of Convolution

Focus on computing the n^{th} output sample.

$$y[5] = \sum_{k=-\infty}^{\infty} x[k]h[5-k]$$

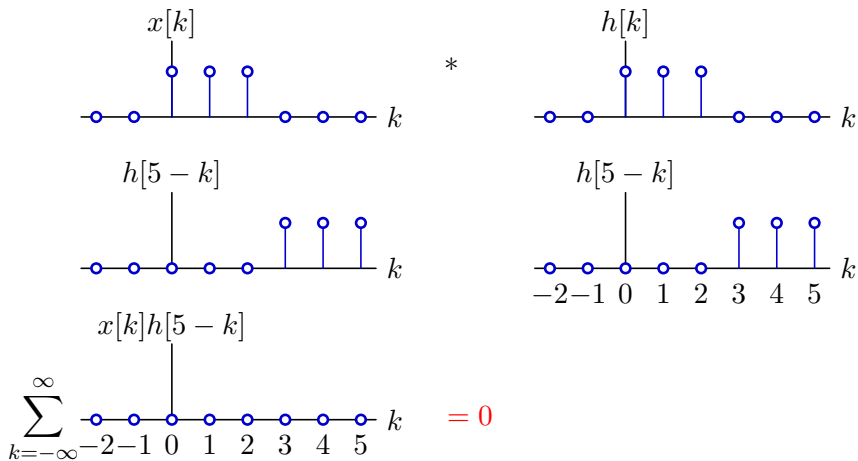

Check Yourself

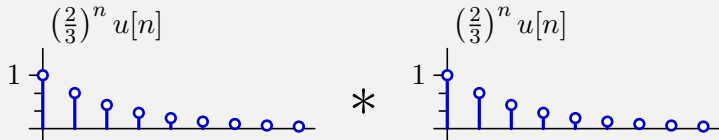

Which plot shows the result of the convolution above?

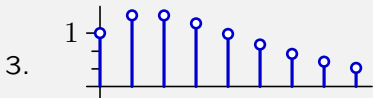
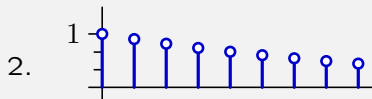
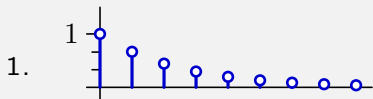

5. none of the above

Check Yourself

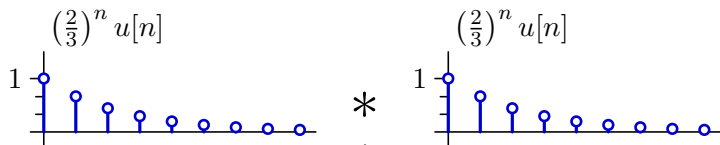

Express mathematically:

$$\begin{aligned} \left(\left(\frac{2}{3} \right)^n u[n] \right) * \left(\left(\frac{2}{3} \right)^n u[n] \right) &= \sum_{k=-\infty}^{\infty} \left(\left(\frac{2}{3} \right)^k u[k] \right) \times \left(\left(\frac{2}{3} \right)^{n-k} u[n-k] \right) \\ &= \sum_{k=0}^n \left(\frac{2}{3} \right)^k \times \left(\frac{2}{3} \right)^{n-k} \\ &= \sum_{k=0}^n \left(\frac{2}{3} \right)^n = \left(\frac{2}{3} \right)^n \sum_{k=0}^n 1 \\ &= (n+1) \left(\frac{2}{3} \right)^n u[n] \\ &= 1, \frac{4}{3}, \frac{4}{3}, \frac{32}{27}, \frac{80}{81}, \dots \end{aligned}$$

Check Yourself

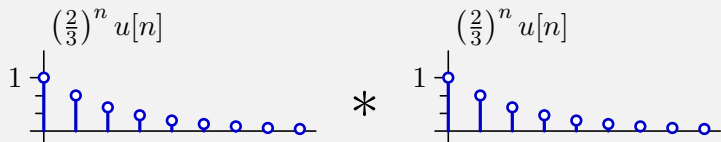

Which plot shows the result of the convolution above? **3**

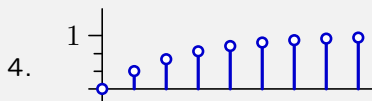
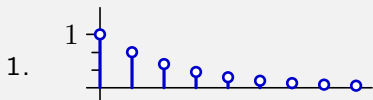

5. none of the above

Unit-Sample Response

The unit-sample response is a **complete** description of a system.

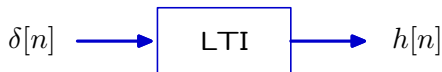

It can be used to determine the response to **any** other input.

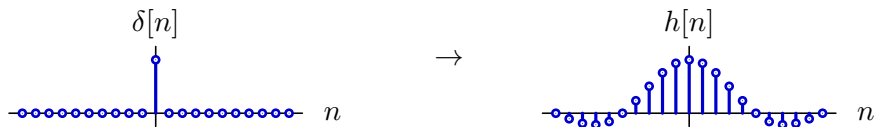

Given $h[n]$ one can compute the response to any arbitrary input signal.

$$y[n] = (x * h)[n] \equiv \sum_{k=-\infty}^{\infty} x[k]h[n-k]$$

Continuous-Time Systems

Superposition and convolution are of equal importance for CT systems.

Impulse Response

A CT system is completely characterized by its **impulse response**, much as a DT system is completely characterized by its unit-sample response.

We have worked with the impulse (Dirac delta) function $\delta(t)$ previously. It's defined in a limit as follows.

Let $p_{\Delta}(t)$ represent a pulse of width Δ and height $\frac{1}{\Delta}$ so that its area is 1.

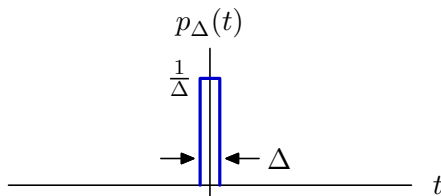

Then

$$\delta(t) = \lim_{\Delta \rightarrow 0} p_{\Delta}(t)$$

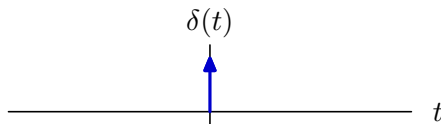

The impulse function can be used to break an arbitrary input $x(t)$ into time-based components, much as $\delta[k]$ is used for discrete-time signals.

Impulse Response

An arbitrary CT signal can be represented by an infinite sum of infinitesimal impulses (which define an integral).

Approximate an arbitrary signal $x(t)$ (blue) as a sum of pulses $p_\Delta(t)$ (red).

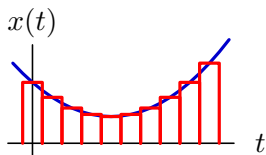

$$x_\Delta(t) = \sum_{k=-\infty}^{\infty} x(k\Delta)p_\Delta(t - k\Delta)\Delta$$

and the limit of $x_\Delta(t)$ as $\Delta \rightarrow 0$ will approximate $x(t)$.

$$\lim_{\Delta \rightarrow 0} x_\Delta(t) = \lim_{\Delta \rightarrow 0} \sum_{k=-\infty}^{\infty} x(k\Delta)p_\Delta(t - k\Delta)\Delta \rightarrow \int_{-\infty}^{\infty} x(\tau)\delta(t - \tau) d\tau$$

The result in CT is much like the result for DT:

$$x(t) = \int_{-\infty}^{\infty} x(\tau)\delta(t - \tau) d\tau \qquad x[n] = \sum_{m=-\infty}^{\infty} x[m]\delta(n - m)$$

Impulse Response

If a system is linear and time-invariant (LTI), its input-output relation is **completely specified** by the system's impulse response $h(t)$.

1. One can always find the impulse response of a system.

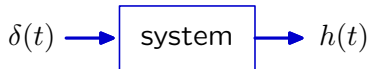

2. Time invariance implies that shifting the input simply shifts the output.

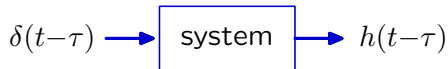

3. Homogeneity implies that scaling the input simply scales the output.

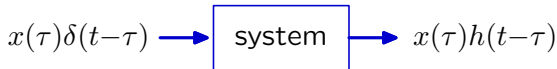

4. Additivity implies that the response to a sum is the sum of responses.

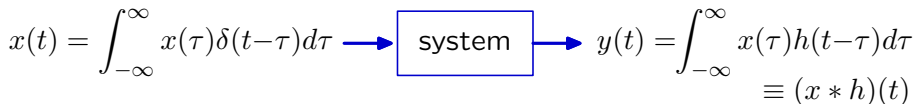

$x(t) = \int_{-\infty}^{\infty} x(\tau)\delta(t-\tau)d\tau \rightarrow \boxed{\text{system}} \rightarrow y(t) = \int_{-\infty}^{\infty} x(\tau)h(t-\tau)d\tau \equiv (x * h)(t)$

Impulse Response

The impulse response is a **complete** description of a system.

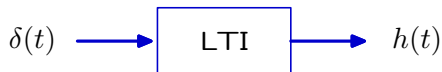

It can be used to determine the response to **any** other input.

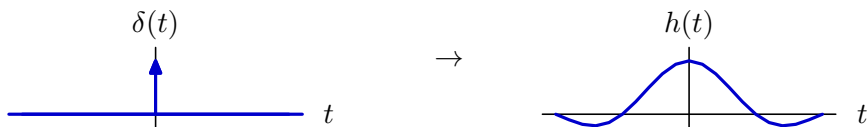

Given $h(t)$ one can compute the response to any arbitrary input signal.

$$y(t) = (x * h)(t) \equiv \int_{-\infty}^{\infty} x(\tau)h(t - \tau)d\tau$$

Comparison of CT and DT Convolution

Convolution of CT signals is analogous to convolution of DT signals.

$$\text{DT: } y[n] = (x * h)[n] = \sum_{k=-\infty}^{\infty} x[k]h[n - k]$$

$$\text{CT: } y(t) = (x * h)(t) = \int_{-\infty}^{\infty} x(\tau)h(t - \tau)d\tau$$

Check Yourself

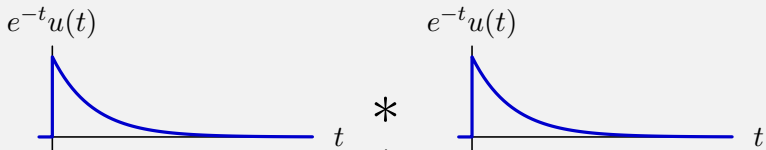

Which plot shows the result of the convolution above?

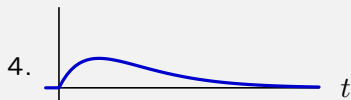
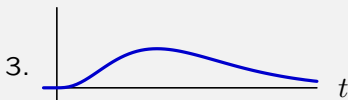
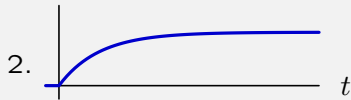
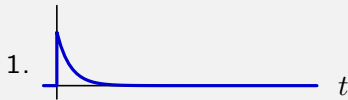

5. none of the above

Check Yourself

Which plot shows the result of the following convolution?

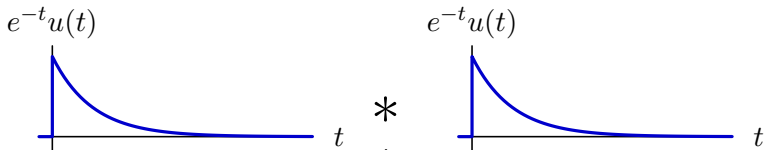

$$\begin{aligned} (e^{-t}u(t)) * (e^{-t}u(t)) &= \int_{-\infty}^{\infty} e^{-\tau}u(\tau)e^{-(t-\tau)}u(t-\tau)d\tau \\ &= \int_0^t e^{-\tau}e^{-(t-\tau)}d\tau = e^{-t} \int_0^t d\tau = te^{-t}u(t) \end{aligned}$$

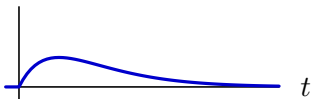

Check Yourself

$$e^{-t}u(t)$$

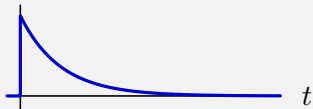

*

$$e^{-t}u(t)$$

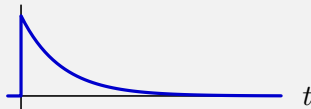

Which plot shows the result of the convolution above? 4

1.

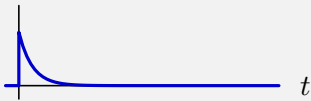

2.

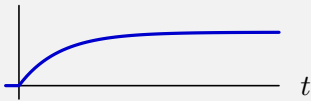

3.

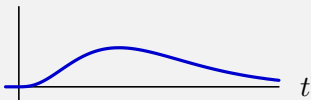

4.

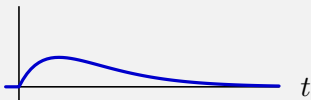

5. none of the above

Properties of Convolution

Commutivity:

$$(x * y)(t) = (y * x)(t)$$

$$(x * y)(t) \equiv \int_{-\infty}^{\infty} x(t - \tau)y(\tau) d\tau$$

let $\lambda = t - \tau$

$$\begin{aligned}(x * y)(t) &= \int_{\infty}^{-\infty} x(\lambda)y(t - \lambda)(-d\lambda) \\ &= \int_{-\infty}^{\infty} x(\lambda)y(t - \lambda) d\lambda \\ &= (y * x)(t)\end{aligned}$$

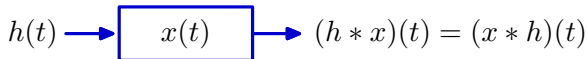
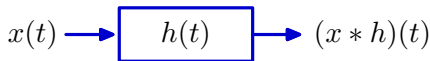

Properties of Convolution

Associativity.

$$\left((x * y) * z \right)(t) = \left(x * (y * z) \right)(t)$$

$$\left((x * y) * z \right)(t) \equiv \int_{-\infty}^{\infty} \left(\int_{-\infty}^{\infty} x(t - \lambda - \tau) y(\tau) d\tau \right) z(\lambda) d\lambda$$

let $\mu = \lambda + \tau$

$$\begin{aligned} \left((x * y) * z \right)(t) &= \int_{-\infty}^{\infty} \left(\int_{-\infty}^{\infty} x(t - \mu) y(\mu - \lambda) d\mu \right) z(\lambda) d\lambda \\ &= \int_{-\infty}^{\infty} x(t - \mu) \left(\int_{-\infty}^{\infty} y(\mu - \lambda) z(\lambda) d\lambda \right) d\mu \\ &= \left(x * (y * z) \right) \end{aligned}$$

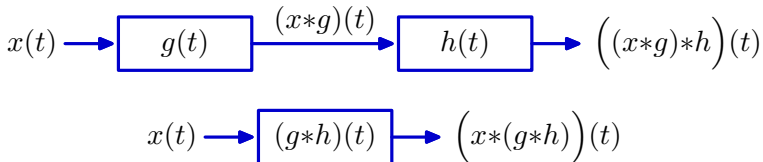

Properties of Convolution

Distributivity over addition.

$$(x * (g + h))(t) = (x * g)(t) + (x * h)(t)$$

$$\begin{aligned}(x * (g + h)) &= \int_{-\infty}^{\infty} x(t - \tau) (g(\tau) + h(\tau)) d\tau \\ &= \int_{-\infty}^{\infty} x(t - \tau) g(\tau) d\tau + \int_{-\infty}^{\infty} x(t - \tau) h(\tau) d\tau \\ &= (x * g)(t) + (x * h)(t)\end{aligned}$$

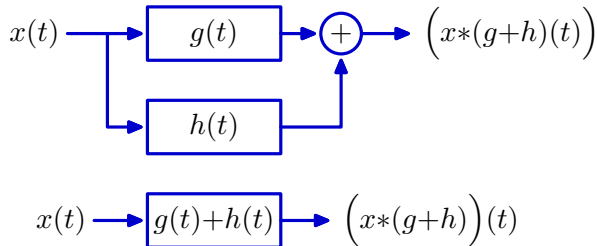

Check Yourself

Match expressions on the left with functions on the right where

$$f(t) = e^{-t} u(t)$$

$$g(t) = e^t u(-t)$$

$$(f * f)(t) \quad \square$$

$$(g * g)(t) \quad \square$$

$$(f * g)(t) \quad \square$$

$$(g * f)(t) \quad \square$$

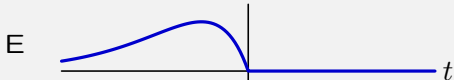
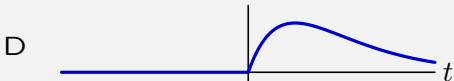
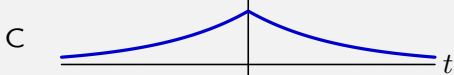
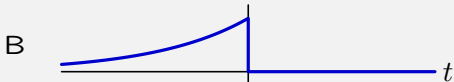

CT Convolution

Let

$$f(t) = e^{-t} u(t)$$

$$g(t) = e^t u(-t)$$

Find $(f * f)(t)$, $(g * g)(t)$, $(f * g)(t)$, and $(g * f)(t)$.

$$(f * f)(t) = \int_{-\infty}^{\infty} f(\tau) f(t - \tau) d\tau = \int_{-\infty}^{\infty} e^{-\tau} u(\tau) e^{-(t-\tau)} u(t - \tau) d\tau$$

The integrand is zero unless $\tau > 0$ and $t - \tau > 0$.

Therefore $0 < \tau < t$ and $t > 0$.

$$(f * f)(t) = e^{-t} \int_0^t d\tau u(t) = t e^{-t} u(t)$$

Answer: D

CT Convolution

Let

$$f(t) = e^{-t} u(t)$$

$$g(t) = e^t u(-t)$$

Find $(f * f)(t)$, $(g * g)(t)$, $(f * g)(t)$, and $(g * f)(t)$.

Since $g(t) = f(-t)$,

$$(g * g)(t) = \int_{-\infty}^{\infty} g(\tau)g(t - \tau) d\tau = \int_{-\infty}^{\infty} f(-\tau)f(-t + \tau) d\tau$$

Now let $\lambda = -\tau$:

$$\begin{aligned}(g * g)(t) &= \int_{\infty}^{-\infty} f(\lambda)f(-t - \lambda) (-d\lambda) \\ &= \int_{-\infty}^{\infty} f(\lambda)f(-t - \lambda) d\lambda \\ &= (f * f)(-t)\end{aligned}$$

Answer: E

CT Convolution

Let

$$f(t) = e^{-t} u(t)$$

$$g(t) = e^t u(-t)$$

Find $(f * f)(t)$, $(g * g)(t)$, $(f * g)(t)$, and $(g * f)(t)$.

$$(f * g)(t) = \int_{-\infty}^{\infty} f(\tau)g(t - \tau) d\tau = \int_{-\infty}^{\infty} e^{-\tau}u(\tau)e^{t-\tau}u(\tau - t) d\tau$$

The integrand is zero unless $\tau > 0$ and $\tau > t$. Therefore $\tau > \max(0, t)$.

$$(f * g)(t) = \begin{cases} e^t \int_0^{\infty} e^{-2\tau} d\tau = \frac{1}{2}e^t & \text{if } t < 0 \\ e^t \int_t^{\infty} e^{-2\tau} d\tau = \frac{1}{2}e^{-t} & \text{if } t > 0 \end{cases}$$

$$= \frac{1}{2}e^{-|t|}$$

$$= (g * f)(t) \quad \text{since convolution is commutative}$$

Answer: C

Check Yourself

Match expressions on the left with functions on the right where

$$f(t) = e^{-t} u(t)$$

$$g(t) = e^t u(-t)$$

$$(f * f)(t)$$

D

$$(g * g)(t)$$

E

$$(f * g)(t)$$

C

$$(g * f)(t)$$

C

A

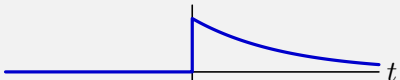

B

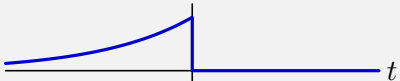

C

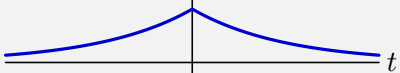

D

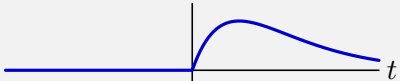

E

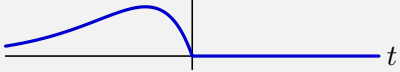

F

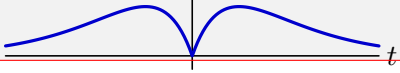

Summary

The response of a discrete-time, LTI system to an input $x[n]$ can be computed by convolving the input with the system's **unit sample response**.

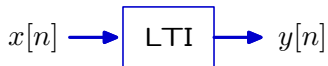

$$y[n] = \sum_{k=-\infty}^{\infty} x[k]h[n-k] \equiv (x * h)[n]$$

The response of a continuous-time, LTI system to an input $x(t)$ can be computed by convolving the input with the system's **impulse response**.

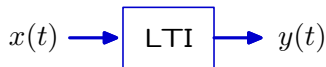

$$y(t) = \int_{-\infty}^{\infty} x(\tau)h(t-\tau)d\tau \equiv (x * h)(t)$$

Convolution allows us to represent a system by a **single signal!**